



AZ-4CP/AZ-6CP



New!

AZ-4P/AZ-6P



AZ3/AZ5



ARGO zone valve controls are now more flexible and convenient than ever before

AZ-4CP ■ AZ-6CP ■ AZ-4P ■ AZ-6P ■ AZ-3 ■ AZ-5

**Advanced
Technology
At Work
For You!**

AZ-4CP/AZ-6CP Four and Six Zone Valve Controls with Built-in Circulator or Zone Valve Priority Option

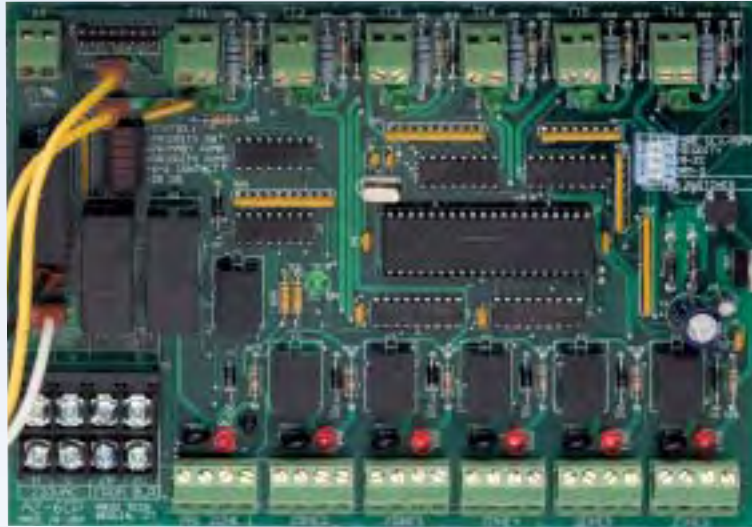

AZ-6CP

Electrical Specifications

MODEL NUMBER	ZONES	TRANSFORMER VOLTAGE	RELAY SWITCHING ACTION	MAX. TOTAL AMP DRAW
AZ-4CP	4	120V / 60Hz / 40Va	SPST	7.2A
AZ-6CP	6	120V / 60Hz / 75Va	SPST	7.2A

Ideal For Indirect Hot Water Applications

- Choice of circulator or zone valve for priority
- Optimum performance with circulator priority, increasing hot water flow up to 20%
- Option for tankless coil boiler applications

Application Flexibility

- Four (AZ-4CP) or six (AZ-6CP) zone valve controller with priority
- Switchable priority (ON/OFF)
- Priority zone is field configurable for use with either circulator or zone valve
- Controls three or four wire 24v zone valves

Installation and Service Features

- Front window with clearly visible LED diagnostic lights showing zones calling and those satisfied
- Design compatible with all types of thermostats, and ensures relays energize with power robbing thermostats
- Auto reset fuse prevents nuisance calls
- Expandable to 10 zones with Priority utilizing two AZ Controls
- Clearly marked terminal for easy and accurate installation
- 5 year warranty, 100% factory tested, made in USA

Wiring Diagram Notes:

1. The switching relay terminals are approved for use with copper wires only. Torque terminal block screws 6 to 7 inch pounds.
2. When using a priority zone circulator, a jumper is required between terminals 3 and 4 of Priority Zone 1. This jumper is not required when using a zone valve.

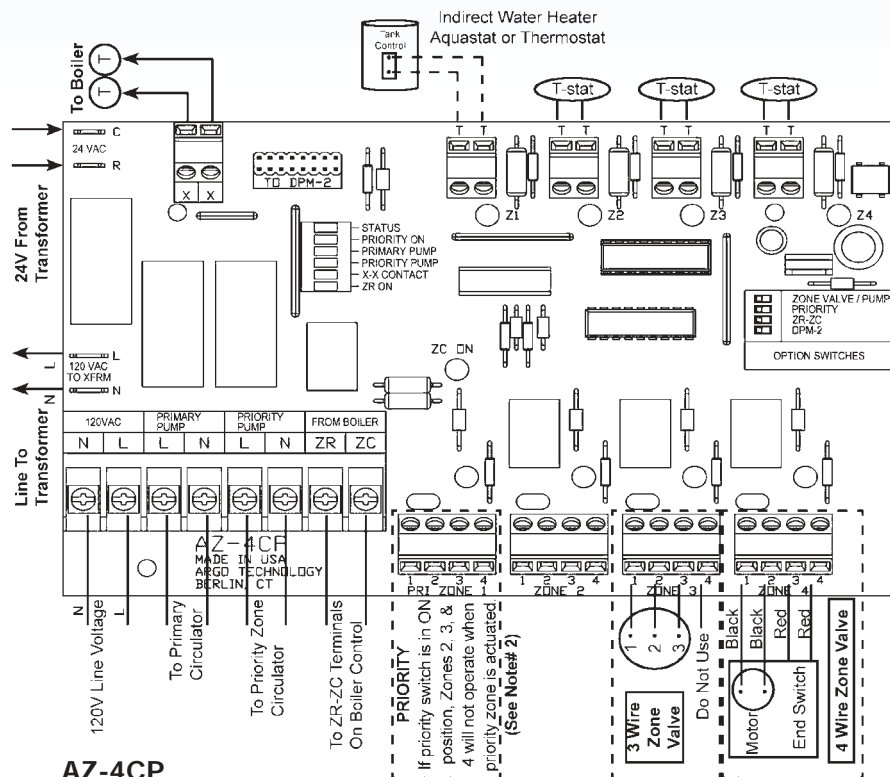

AZ-4P/AZ-6P Four and Six Zone Valve Controls with Priority



Application Flexibility

- Four (AZ-4P) or six (AZ-6P) zone valve controller with priority
- Built-in priority for indirect hot water heater applications
- Switchable priority (ON/OFF)
- Controls three or four wire 24v zone valves

Installation and Service Features

- Front window with clearly visible LED diagnostic lights for easy troubleshooting
- Easy replacement with plug-in priority and isolated relays
- Clearly marked terminal for easy and accurate installation
- 5 year warranty, 100% factory tested, made in USA

Electrical Specifications

MODEL NUMBER	ZONES	TRANSFORMER VOLTAGE	RELAY SWITCHING ACTION	END SWITCH CONTACT RATING
AZ-4P	4	120V / 60Hz / 40Va	SPST	5A-1/8 HP @120VAC
AZ-6P	6	120V / 60Hz / 75Va	SPST	5A-1/8 HP @120VAC

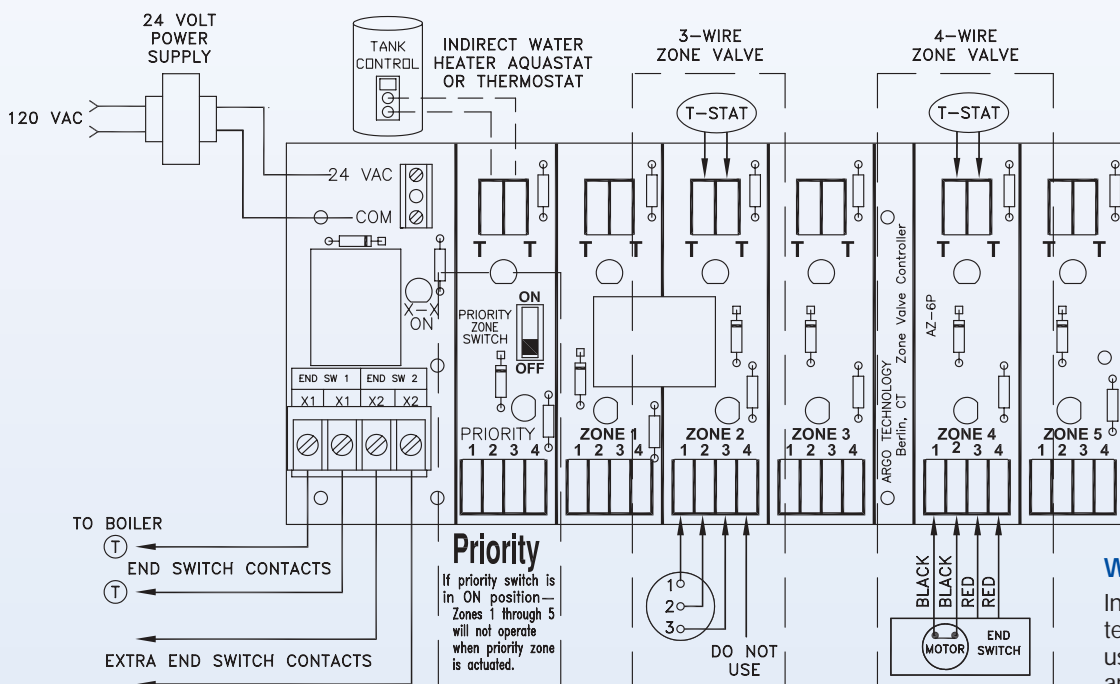

AZ-3/AZ-5 Three and Five Zone Valve Controls

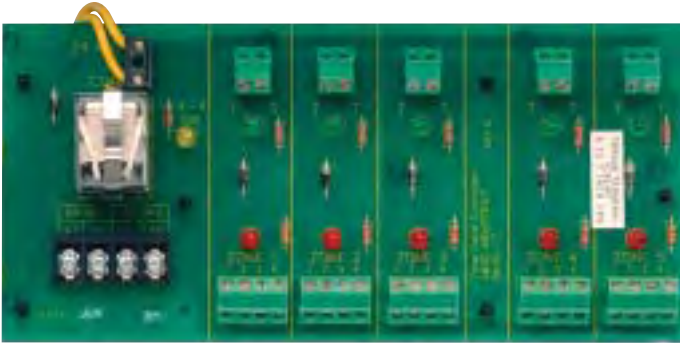

Electrical Specifications

MODEL NUMBER	ZONES	TRANSFORMER VOLTAGE	END SWITCH CONTACT RATING
AZ-3	3	120V / 60Hz / 40Va	5A-1/8 HP @120VAC
AZ-5	5	120V / 60Hz / 75Va	5A-1/8 HP @120VAC

Application Flexibility

- Three (AZ-3) or five (AZ-5) zone valve controller
- Controls three or four wire 24v zone valves

Installation and Service Features

- LED diagnostic lights for easy troubleshooting
- Clearly marked terminal for easy and accurate installation
- 5 year warranty, 100% factory tested, made in USA

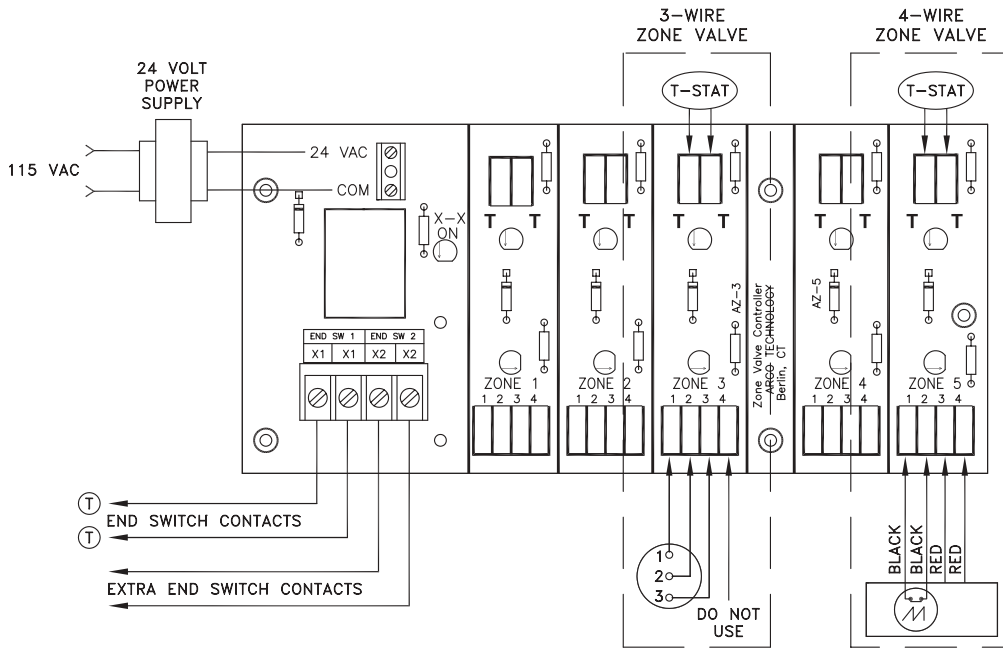

Wiring Diagram Note:

Install with jumper between terminals 3 and 4 when using zone valve without an end switch.

DPM2 Outdoor Reset Control

The DPM2 monitors outside temperature and adjusts boiler water temperature to match the outdoor demand – maximizing efficiency and reducing fuel usage.

- Can be used with any Argo Relay or Zone Valve Control
- Or can work with most competitors' relays
- Reduces heating costs an average of 10% to 15% a year (depending on climate).

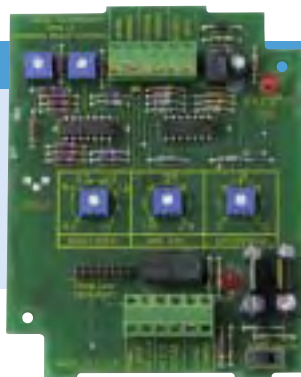

STANDARD EQUIPMENT:

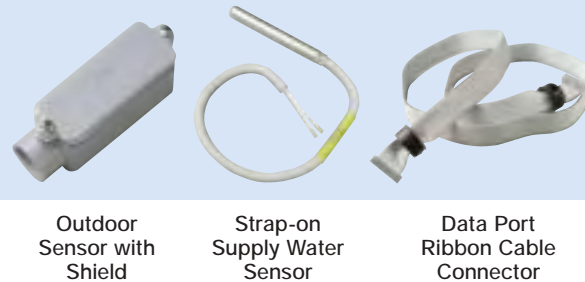

Argo ARGUMENT TECHNOLOGY, INC.

USA Homeowner Assistance: 866-847-6656



P.O. Box 4729, Utica, New York 13504 • Phone: 315-797-1310 • Fax: 866-432-7329 • www.argoindustries.com • E-mail: info@ecrinternational.com

In Canada Contact: ECR International Ltd. - Olsen Division, P.O. Box 900, 6800 Base Line, Wallaceburg, Ontario, Canada N8A 5E5

An ECR International Brand

Ph: (519) 627-0791 • Fax: (519) 627-4719 • Web: www.ecrltd.com • E-mail: info@ecrltd.com

P/N 240005997 - 8/06